

# Ramp/Soak Controller

Ramp/Soak Controller  
(Temperature/Process Controller)

## PZ Series



 Reinforced Insulation

Large three display

# At-a-glance view of current status

The large LCD display provides various information about the control status. It is obvious at first glance to see the program running properly.



PZ400

PZ900

PV-value

SV-value

Program output

MV 68.9

Program elapsed time

H:M 16:52

M:S 30:56

CT1/CT2 value

CT1 12.8

Running pattern/  
Segment display

Ramp/Soak Status

5-digit PV/SV display

# High resolution display for high temperature ranges

The high resolution display is suitable for various industrial furnaces, ovens and pottery kilns that need high temperature ranges.

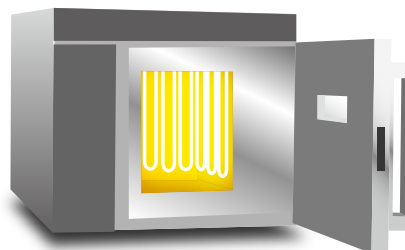

## Automatic level setting Overall Level Autotuning

# Automatic configuration for each machine

Level-PID function is available on many of our program controllers. Multiple PID levels are automatically calculated and set by the controller itself. The controller automatically completes the initial setup, requiring no advanced skills.

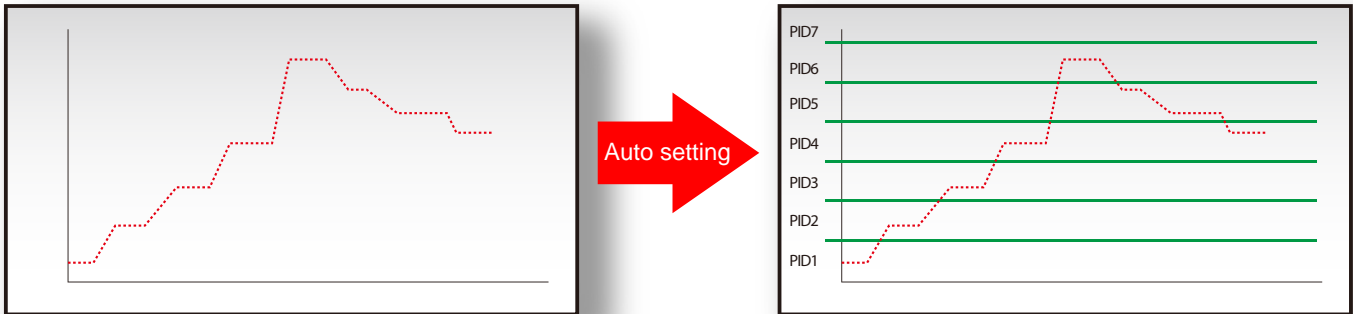

The Controller automatically recognizes the soak level inside the pattern and performs Autotuning at the recognized level. After the autotuning is completed, the calculated PID values are automatically set to the level.

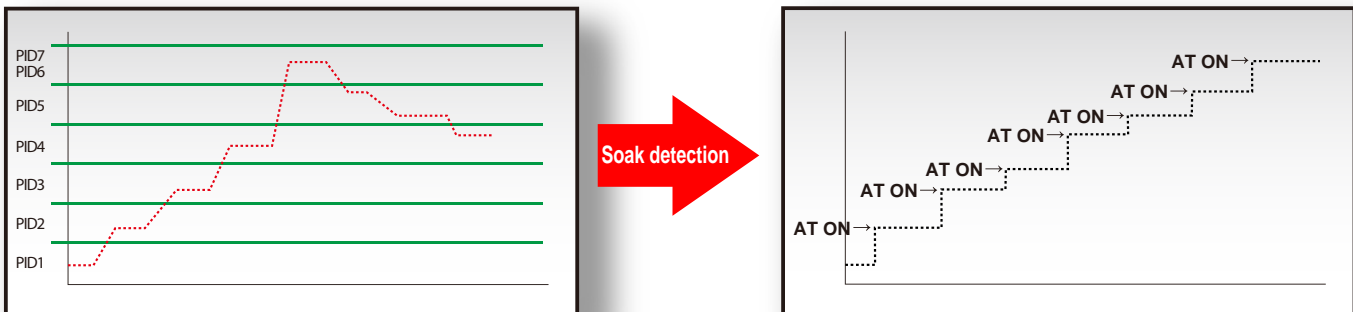

## Customizable keys

# Realize easy operation

Frequently used functions are assignable to direct keys for quick and easy access. This prevents operators' errors and enables easy key operations.



## Loader communication and Dedicated software

# Easy initial setup. Controller can be quickly replaced.

All models are supplied with a front loader port as standard. Configuration can be set from the computer without removing the controller from the panel.  
Saved configuration data can be sent to the controller from your computer on your desk.



Front loader communication port

Loader communication cable  
Length : 1.5m  
Model code for cable only :  
W-BV-05-1500

### USB communication converter COM-K2

COM-K2-4  
(With loader communication cable)  
COM-K2-N  
(Without loader communication cable)

The power to COM-K2 is supplied from the PC via the USB port so no power supply is necessary.

Length :1m  
(Complete with loader communication cable)

USB

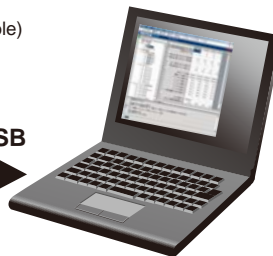

## Easy Data Management Communication Tool **PROTEM 2**

Data monitoring, setting, storage, copy, transfer, logging, and report creation



Simply download "PROTEM2" from the RKC Instrument web site ([www.rkcinst.com](http://www.rkcinst.com)).

# Various functions comparable to higher end models adapt the controller suitable for many applications.

Applicable for the mid-scale program control applications

Max. 256 segments  
 (16 patterns by 16 segments)  
 Up to four individual time signal outputs per pattern  
 The use of logic operation enables handling complicated external sequences up to four points per DO.

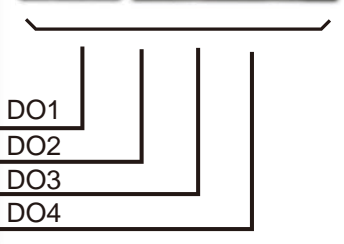
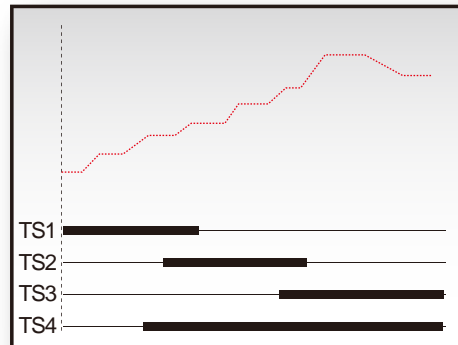

## Programless connection to PLCs (Optional)

**PLC Special Protocol**  
 (MAPMAN Function)

A PLC special protocol (MAPMAN) function becomes a Master Unit to PLC, and automatically stores temperature data into registers in a PLC. This enables easy handling of temperature control system to the exiting PLC system is available.

(MITSUBISHI PLC Protocol : QnA compatible, 3C frame (type 4))  
**MAPMAN** MITSUBISHI MELSEC series



## Flexible Output Configuration



**OUT1,OUT2**  
 : Relay contact/Voltage pulse/Current/Continuous voltage/Transistor output  
**OUT3**  
 : Voltage pulse/Current (Universal output)  
**DO1, DO2, DO3, DO4**  
 : Relay contact  
 Output type is freely changeable to meet the requirements of different applications.

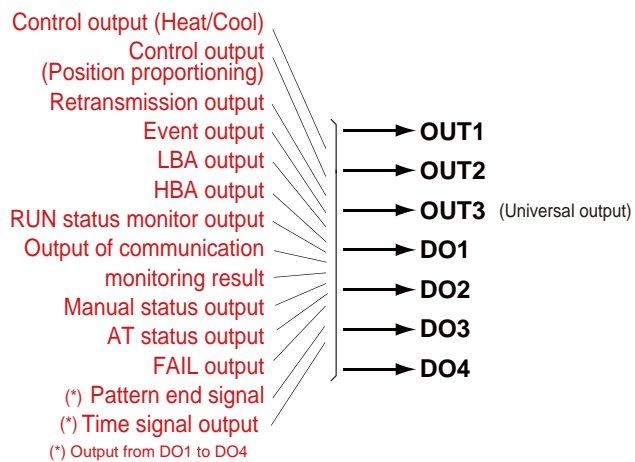

# Specifications

## ● Measured Input (Universal Inputs)

Inputs	<ul style="list-style-type: none"> <li>• Universal input (Use dip switch to change input group.)</li> <li>a) Temperature, Current, Low voltage input group           <ul style="list-style-type: none"> <li>Thermocouple : K, J, E, T, R, S, B, N (JIS/IEC), PLII (NBS), W5Re/W26Re (ASTM), U, L (DIN), PR40-20</li> <li>RTD : Pt100 (JIS/IEC), JPt100 (JIS) • 3-wire system</li> <li>Low voltage : 0 to 100mV, 0 to 10mV DC</li> </ul> </li> <li>b) High voltage input group (Input impedance : 1MΩ)           <ul style="list-style-type: none"> <li>0 to 1V DC, 0 to 5V DC, 1 to 5V DC, 0 to 10V DC</li> <li>-5 to +5V, -10 to +10V</li> </ul> </li> <li>c) Current input group (Input impedance : 50Ω)           <ul style="list-style-type: none"> <li>4 to 20mA, 0 to 20mA</li> </ul> </li> </ul>
Sampling Time	0.05 sec

## ● Control

Control action	PID control, Heat/Cool type PID control, Position proportioning control without feedback resistance <ul style="list-style-type: none"> <li>• P, PI, PD, ON/OFF control selectable</li> <li>• Direct action/Reverse action is selectable</li> </ul>
Level-PID autotuning	Function to search program soaks in the RESET mode and perform Autotuning in the order of segments.
Control mode	Reset Mode (RESET) / Program Control Mode (RUN) Fix control mode (FIX) / Manual Control Mode (MAN),

## ● Program Control

Number of program patterns	Up to 16 patterns
Number of program segments	Up to 16 segments/pattern <ul style="list-style-type: none"> <li>• Pattern linkable : Up to 256 segments.</li> <li>• With HOLD, STEP function</li> </ul>
Segment time	0 hr 0 min to 199 hs 59 min or 0 min 0 sec to 199 min 59 sec
Number of pattern repeat	1 to 10,000 repeats <ul style="list-style-type: none"> <li>• Continuous repeat when set to 10,000.</li> </ul>
Pattern end output time	0 hr 0 min to 199 hs 59 min or 0 min 0 sec to 199 min 59 sec <ul style="list-style-type: none"> <li>• Output remains on when set to zero.</li> </ul>
	a) Wait zone (upper) <ol style="list-style-type: none"> <li>1) Temperature input: 0 (0.0/0.00) to 200 (200.0/200.00)(°C, °F)</li> <li>2) Voltage/current input: 0.0 to 20.0% of input span             <ul style="list-style-type: none"> <li>• Wait function off when set to zero</li> </ul> </li> </ol>
	b) Wait zone (lower) <ol style="list-style-type: none"> <li>1) Temperature input: -200(-200.0)~0(0.0)(°C, °F) or -199.99~0.00(°C, °F)</li> <li>2) Voltage/current input: 20.0~0.0% of input span             <ul style="list-style-type: none"> <li>• Wait function off when set to zero</li> </ul> </li> </ol>
Time signal output	a) Number of outputs: 4 (TS1 to TS4) b) Output assignment: DO1 to DO4 c) Setting range <ul style="list-style-type: none"> <li>Program pattern select : 1 to 16</li> <li>Start segment : 1 to 16</li> <li>Start time : 0 hr 0 min to 199 hs 59 min or 0 min 0 sec to 199 min 59 sec</li> <li>End segment : 1 to 16</li> <li>End time : 0 hr 0 min to 199 hs 59 min or 0 min 0 sec to 199 min 59 sec</li> </ul>
Level PID	a) Number of levels : 8 levels b) Setting range : Low input range to High input range

## ● Performance

Input Type	Range	Accuracy
K, J, T, E, U, L	Lower than -100°C (-148°F)	± (1.0°C [1.8°F] + 1 digit)
	-100 to 500°C (-148 to 932°F)	± (0.5°C [0.9°F] + 1 digit)
	500°C (932°F) or higher	± (0.1% of Reading + 1 digit)
N, R, S, PLII W5Re/W26Re	Lower than 0°C (32°F)	± (2.0°C [3.6°F] + 1 digit)
	0 to 1000°C (32 to 1832°F)	± (1.0°C [1.8°F] + 1 digit)
	1000°C (1832°F) or higher	± (0.1% of Reading + 1 digit)
B	Lower than 400°C (752°F)	± (7.0°C [126°F] + 1 digit)
	400 to 1000°C (752 to 1832°F)	± (1.4°C [2.52°F] + 1 digit)
	1000°C (1832°F) or higher	± (0.1% of Reading + 1 digit)
PR40-20	Lower than 400°C (752°F)	± (20°C [36°F] + 1 digit)
	400 to 1000°C (752 to 1832°F)	± (10°C [18°F] + 1 digit)
	1000°C (1832°F) or higher	± (0.1% of Reading + 1 digit)
Pt100, JPt100	Lower than 200°C (392°F)	± (0.2°C [0.36°F] + 1 digit)
	200°C (392°F) or higher	± (0.1% of Reading + 1 digit)
	0.00 to 50.00°C (90.00°F)	± (0.10°C [0.18°F] + 1 digit)
Voltage/Current	-span to +span	± (0.1% of span + 1 digit)

\*1 : Accuracy is not guaranteed for less than -100°C.

\*2 : Accuracy is not guaranteed for less than 400°C (752°F) for Input Type R, S, B, PR20-40, and W5Re/W26Re.

## ● Output

Relay contact output (1), [OUT1]	a) Contact type : 1a contact, 250V AC 3A, 30V DC 1A (Resistive load) b) Electric life : 100,000 operations or more (Rated load) c) Mechanical life : 20,000,000 operations or more (Switching: 300 times/min)
Relay contact output (2), [OUT2]	a) Contact type : 1a contact, 250V AC 3A, 30V DC 1A (Resistive load) b) Electric life : 300,000 operations or more (Rated load) c) Mechanical life : 50,000,000 operations or more (Switching: 180 times/min)
Relay contact output (3), [DO1 to DO4]	a) Contact type : 1a contact, 250V AC 1A, 30V DC 0.5A (Resistive load) b) Electric life : 150,000 operations or more (Rated load) c) Mechanical life : 20,000,000 operations or more (Switching: 300 times/min)
Voltage pulse output (1), [OUT1, OUT2]	0/12V DC (Load resistance : More than 500Ω)
Voltage pulse output (2), [OUT3]	0/14V DC (Load resistance : More than 600Ω)
Current output [OUT1, OUT2]	4 to 20mA, 0 to 20mA (Load resistance : Less than 500Ω)
Continuous voltage output [OUT1, OUT2]	0 to 5V DC, 1 to 5V DC, 0 to 10V DC (Load resistance : More than 1kΩ)
Transistor output [OUT1, OUT2]	a) Load voltage : Less than 30V DC b) Load current : Less than 100mA

OUT1 to OUT3 : Control output, Analog output, Event, Heater break alarm, Control loop break alarm  
 RUN status, MAN status, FAIL  
 DO1 to DO4 : Time signal, Pattern end signal  
 Event, Heater break alarm, Control loop break alarm  
 RUN status, MAN status, FAIL  
 OUT3 (Optional) : Voltage pulse, Current output (Universal output)

## ● Event, Alarm function

(Optional)

Number of events	Up to 4 points
Event type	Process high, Process low, Process high/low*1, Deviation high, Deviation low, Deviation high/low*1, Band*1, MV value high (Heat/Cool), MV value low (Heat/Cool), FBR input *1: Two types of alarm settings are field-selectable. <ol style="list-style-type: none"> <li>1. Independent high and low settings.</li> <li>2. Common high/low setting</li> </ol> <ul style="list-style-type: none"> <li>• Hold/Re-hold action, Delay timer, Energized/de-energized action, Interlock (latch) function, Alarm lamp ON condition available.</li> </ul>
Event output	Assigned to digital output
Control loop break alarm (LBA)	LBA time : 0 to 7200 sec (LBA is OFF when 0 is set.) Dead band : 0 to input span
Heater break alarm (HBA)	Number of alarm : 2 points (1 point per CT input) Setting range : 0.0 to 100.0A (0.0: HBA function OFF)
Output logic calculation	OR select from Event 1 to 4, HBA1/2, LBA and Input abnormal high/low

## ● Current Transformer (CT) Input

(Optional)

Number of events	Up to 2 points
CT Type	CTL-6-P-Z, CTL-6-P-N, CTL-12-S56-10L-N
CT input range	CTL-6-P-Z : 0.0 to 10.0A (High accuracy type) CTL-6-P-N : 0.0 to 30.0A CTL-12-S56-10L-N : 0.0 to 100.0A
Sampling time	0.5 sec

## ● Feedback Resistance (FBR) Input

(Optional)

Resistance value	100 to 10kΩ (factory default 135Ω)
Sampling time	0.5 sec

## ● Digital Input (DI)

(Optional)

Number of inputs	Up to 6 points (DI 1 to 6)
Input method	Non-voltage contact input
Function	Run, Reset, Direct/Reverse action, HOLD/HOLD reset, Step Autotuning ON/OFF, Setting data Unlock/Lock, Interlock release, Peak/Bottom hold reset

## ● Host communication

(Optional)

Communication method	RS-485, RS-422A
Protocol	a) ANSI X3.28 sub-category 2.5A4 (RKC standard) b) MODBUS-RTU c) PLC communication (MAPMAN)
Bit format	Data bit : 7 or 8 (MODBUS-RTU : 8 bit fix) Parity bit : 1(odd or even) or none, Stop bit : 1 or 2
Communication speed	2400bps, 4800bps, 9600bps, 19200bps, 38400bps, 57600bps
Maximum connection	31 units

## ● Loader communication

(Standard)

Protocol	ANSI X3.28 sub-category 2.5A4 (RKC standard)
Communication speed	38400bps
Method of connection	Exclusive cable (COM-K2)

## ● General Specifications

Supply voltage	a) 85 to 264V AC (50/60Hz, Selectable), Rating : 100 to 240V AC b) 20.4 to 26.4V AC (50/60Hz, Selectable), Rating : 24V AC c) 20.4 to 26.4V DC Rating : 24V DC
Power consumption/ Rush current	a) 100 to 240V AC type PZ400 : Max. 6.8VA (100V), Rush current : Less than 5.6A Max. 10.1VZ (240V), Rush current : Less than 13.3A PZ900 : Max. 7.4VA (100V), Rush current : Less than 5.6A Max. 10.9VA (200V), Rush current : Less than 13.3A b) 24V AC type PZ400 : Max. 6.9VA (24V), Rush current : Less than 16.3A PZ900 : Max. 7.4VA (24V), Rush current : Less than 16.3A c) 24V DC type PZ400 : Max. 175mA (24V), Rush current : Less than 11.5A PZ900 : Max. 190mA (24V), Rush current : Less than 11.5A
Insulation resistance	More than 20MΩ (500V DC) between measured terminals and ground More than 20MΩ (500V DC) between power terminals and ground
Dielectric voltage	1500V AC for one minute between measured terminals and ground 1500V AC for one minute between power terminals and ground
Power failure	a) 100 to 240V AC, 24V AC type A power failure of 20m sec or less will not affect the control action. b) 24V DC type A power failure of 5m sec or less will not affect the control action.
Memory backup	Backed up by non-volatile memory (FRAM) <ul style="list-style-type: none"> <li>• Data retaining period : Approx. 10 years</li> <li>• Number of writing : Approx. 1,000,000,000,000,000 times. (Depending on storage and operating conditions.)</li> </ul>
Waterproof/Dustproof (Optional)	IP65 (IEC60529) <ul style="list-style-type: none"> <li>• Waterproof/Dustproof protection only effective from the front in panel mounted installation.</li> <li>• When the front loader connector cover is not installed: IP00</li> </ul>
Ambient temperature	-10 to +55°C (14 to 131°F)
Ambient humidity	5 to 95% RH (Non condensing) (MAX.W.C 29g/m <sup>3</sup> dry air at 101.3kPa)
Weight	PZ400 : Approx.221g, PZ900 : 291g
Compliance with Standards	a) UL : UL61010-1 b) cUL : CAN/CSA-C22.2 No.61010-1 c) CE Mark : LVD: EN61010-1, EMC: EN61326-1 RoHS: EN50581 d) RCM : EN55011

# Model and Suffix Codes

		①	②	③	④	⑤	⑥	⑦	⑧	⑨	⑩
48 x 96mm (1/8 DIN Vertical size)		PZ400	□	□	□	□	□	□	□	□	□
96 x 96mm (1/4 DIN size)		PZ900	□	□	□	□	□	□	□	□	□
① Control Method	PID control with AT (Reverse action) PID control with AT (Direct action) Heat/Cool PID control with AT Heat/Cool PID control with AT for extruder (Air cooling type) Heat/Cool PID control with AT for extruder (Water cooling type) Position proportional PID control without FBR (Reverse action) Position proportional PID control without FBR (Direct action)	F D A G W Z C									
② Input and range	See Input range Code Table		□	□	□						
③ Output 1 (OUT1)	Not supplied					N					
	Relay contact output					M					
	Voltage pulse output (0/12V DC)					V					
	DC mA, V See Output Code Table					□					
	Transistor output					B					
④ Output 2 (OUT2)	Not supplied					N					
	Relay contact output					M					
	Voltage pulse output (0/12V DC)					V					
	DC mA, V See Output Code Table					□					
	Transistor output					B					
⑤ Power Supply	24V AC/DC						3				
	100 to 240V AC						4				
⑥ Digital output	Digital output 1 point							1			
	Digital output 4 points							4			
⑦ Option 1	Not supplied								N		
	CT input 2 points (CTL-6-P-N)								T		
	CT input 2 points (CTL-12-S56-10L-N)								U		
	CT input 2 points (CTL-6-Z)								V		
	Feedback resistance input (FBR)								W		
⑧ Option 2	Not supplied									N	
	Output 3 (OUT3)									A	
	Digital input 1 to 6 (DI1 to 6)									B	
	Communication RS-422A									C	
	Communication RS-485									D	
	Output 3 (OUT3) + Digital input 1 to 6 (DI1 to 6)									E	
	Output 3 (OUT3) + Communication RS-422A									F	
	Output 3 (OUT3) + Communication RS-485									G	
	Output 3 (OUT3) + Digital input 1 to 4 (DI1 to 4) + Communication RS-422A									H	
	Output 3 (OUT3) + Digital input 1 to 6 (DI1 to 6) + Communication RS-485									J	
⑨ Waterproof/Dustproof	Not supplied									N	
	Waterproof/Dustproof protection (IP65)									1	
⑩ Quick start code	No quick start code (Default setting)										N
	Specify quick start code (DO type)										1

< Default setting of Output 1 (OUT1), Output 2 (OUT2), and Digital output >

- Output 1 : Control output
- Output 2 : Heat/Cool PID control : Cooling side output  
Position proportioning PID control : Closing side output  
PID control : Output 2 < Code 4 to 8 > : Analog retransmission output (PV)  
Output 2 < Code M, V, B > : Control output

< Default setting of Option function >

- CT input  
CT1 assignment: Output 1 (OUT1)  
CT2 assignment: PID control : Output 1 (OUT1)  
Heat/Cool PID control : Output 2 (OUT2)  
Position proportioning PID control : Output 2 (OUT2)
- Output 3 (OUT3)  
Current output (4 to 20mA), Analog retransmission output (PV)
- Digital input (DI)  
Option 2 : Code "B", "E", "J"  
DI1 : RESET, DI2 : RUN, DI3 : STEP, DI4 : HOLD, DI5 : Interlock release, DI6 : Setting data lock/unlock  
Option 2 : Code "H"  
DI1 : RESET, DI2 : RUN, DI3 : STEP, DI4 : HOLD,
- Communication  
When quick start code not specified :  
RKC standard communication (ANSI X3.28-1976)

## Quick start code

Quick start code		①	②	③	④	⑤
① Digital output 1 function	None See Digital output function code table	N	□	□	□	□
② Digital output 2 function	None See Digital output function code table	N	□	□	□	□
③ Digital output 3 function	None See Digital output function code table	N	□	□	□	□
④ Digital output 4 function	None See Digital output function code table	N	□	□	□	□
⑤ Communication	When "Communication" is not specified as an option, only "N: None" is selectable as the communication protocol.					N
	ANSI/RKC standard protocol					1
	MODBUS protocol					2
	PLC communication: MITSUBISHI MELSEC series special protocol					3

## Digital output function code table

A	Deviation High
B	Deviation Low
C	Deviation High/Low
D	Band
E	Deviation High with Hold
F	Deviation Low with Hold
G	Deviation High/Low with Hold
H	Process High
J	Process Low
K	Process High with Hold
L	Process Low with Hold
P	Heater Break Alarm 1 (HBA1)
Q	Heater Break Alarm 2 (HBA2)
R	Control Loop Break Alarm (LBA)
S	FAIL
V	Set value High
W	Set value Low
1	TS1
2	TS2
3	TS3
4	TS4
5	OR output of TS1 and TS2
6	Pattern End
7	RUN status

TS : Time signal

## Measured Range (Universal Inputs)

Input	Measured range	Input	Measured range
K	-200.0 to +400.0°C, -328.0 to +752.0°F -200.0 to +1372.0°C, -328.0 to +2502.0°F	PLII	0.0 to 1390.0°C, 0.0 to 2534.0°F
J	-200.0 to +400.0°C, -328.0 to +752.0°F -200.0 to +1200.0°C, -328.0 to +2192.0°F	W5Re/W26Re	0 to 2300°C, 0 to 4200°F
T	-200.0 to +400.0°C, -328.0 to +752.0°F	U	-200.0 to +600.0°C, -328.0 to +1112.0°F
S	-50.0 to +1768.0°C, -58.0 to +3214.0°F	L	0.0 to 900.0°C, 0.0 to 1652.0°F
R	-50.0 to +1768.0°C, -58.0 to +3214.0°F	PR40-20	0 to 1800°C, 0 to 3200°F
E	-200.0 to +1000.0°C, -328.0 to +1832.0°F	Pt100	-200.0 to +850.0°C, -328.0 to +1562.0°F -100.0 to +100.0°C, -148.0 to +212.0°F 0.00 to 50.00°C, 32.00 to 122.00°F
B	0.0 to 1800.0°C, 0.0 to 3272.0°F	JPt100	-200.0 to +640.0°C, -328.0 to +1184.0°F -100.0 to +100.0°C, -148.0 to +212.0°F 0.00 to 50.00°C, 32.00 to 122.00°F
N	0.0 to 1300.0°C, 0.0 to 2372.0°F		

## Input Range Code Table (Universal input, Field-programmable) Thermocouple

Input	Range	Code
K	0 to 200°C	K01
	0 to 400°C	K02
	0 to 600°C	K03
	0 to 800°C	K04
	0 to 1200°C	K06
	0 to 1372°C	K07
	-199.9 to +300.0°C	K08
	0.0 to 400.0°C	K09
	0.0 to 800.0°C	K10
	0 to 300°C	K14
	-200 to +1372°C	K41
	-200.0 to +1372.0°C	K42
	0 to 800°F	KA1
	0 to 1600°F	KA2
0 to 2502°F	KA3	
J	0 to 200°C	J01
	0 to 400°C	J02
	0 to 600°C	J03
	0 to 800°C	J04
	0.0 to 400.0°C	J08
	-200.0 to +1200.0°C	J29
	0 to 800°F	JA1
	0 to 2192°F	JA3
0 to 400°F	JA6	
T	-199.9 to +400.0°C	T01
	-199.9 to +100.0°C	T02
	-100.0 to +200.0°C	T03
	-200.0 to +400.0°C	T19
	-50 to +1768°C	S06
S	-50.0 to +1768.0°C	S07
	0 to 1600°C	R01
R	-50 to +1768°C	R07
	-50.0 to +1768.0°C	R08
	0.0 to 1600.0°C	R09
	0 to 800°C	E01
E	0.0 to 800.0°C	E23
	0 to 1800°C	B03
B	0.0 to 1800.0°C	B04
	0 to 1300°C	N02
N	0.0 to 1300.0°C	N05
	0 to 1300°C	A01
PLII	0.0 to 1300.0°C	A05
	0 to 2300°C	W03
W5Re/W26Re	0 to 1800°C	F02
PR40-20	0 to 3200°F	FA2
U	-199.9 to +600.0°C	U01
L	0.0 to 900.0°C	L04

## RTD

Input	Range	Code
Pt100	-199.9 to +649.0°C	D01
	-100.0 to +100.0°C	D04
	-100.0 to +200.0°C	D05
	0.0 to 50.0°C	D06
	0.0 to 100.0°C	D07
	0.0 to 200.0°C	D08
	0.0 to 300.0°C	D09
	0.0 to 500.0°C	D10
	-199.9 to +600.0°C	D12
	-200.0 to +200.0°C	D21
	0.00 to 50.00°C	D27
	-100.00 to +100.00°C	D34
	-200.0 to +850.0°C	D35
	-199.9 to +999.9°F	DA1
	0.0 to 500.0°F	DA9
	0.0 to 200.0°C	P08
	-100.00 to +100.00°C	P29
	-200.0 to +640.0°C	P30

## DC Current • voltage

Input	Code	Range
0 to 10mV DC	101	Scale range and decimal point are programmable in the range of -19999 to +99999
0 to 100mV DC	201	
0 to 1V DC	301	
0 to 5V DC	401	
0 to 10V DC	501	
1 to 5V DC	601	
0 to 20mA DC	701	
4 to 20mA DC	801	Factory set value 0.0 to 100.0%
-10 to +10V DC	904	
-5 to +5V DC	905	

## Output Code Table

Output	Code
0 to 5V DC	4
0 to 10V DC	5
1 to 5V DC	6
0 to 20mA DC	7
4 to 20mA DC	8

# Rear Terminals

• Use a solderless terminal for screw size M3, width 5.8mm or less.

PZ900

PZ400

Option

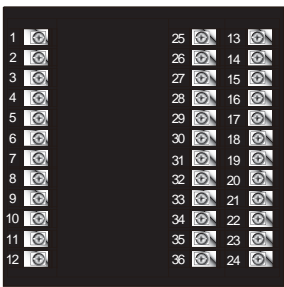

No	Description
1	AC 100-240V DC 24V
2	Power supply
3	Output 2 (OUT2) (1) Relay contact output (2) Voltage pulse/Current/Voltage/Transistor
4	Output 1 (OUT1) (1) Relay contact output (2) Voltage pulse/Current/Voltage/Transistor
5	Output 1 (OUT1) (1) Relay contact output (2) Voltage pulse/Current/Voltage/Transistor
6	Output 1 (OUT1) (1) Relay contact output (2) Voltage pulse/Current/Voltage/Transistor
7	Output 1 (OUT1) (1) Relay contact output (2) Voltage pulse/Current/Voltage/Transistor
8	Digital output 1
9	Relay contact output
10	Measured input
11	(1) Thermocouple (2) RTD (3) Voltage/Current
12	(1) Thermocouple (2) RTD (3) Voltage/Current

No	Description
25	Output 3 (OUT3) Voltage pulse/Current
26	Output 3 (OUT3) Voltage pulse/Current
27	Digital input (DI1 to 6) or (DI1 to 4) Non voltage contact input
28	COM
29	DI 1
30	DI 2
31	DI 3
32	DI 4
33	DI 5
34	DI 6
35	SG
36	T/R(A) T(A) T/R(B) T(B)
	Communication
	(1) RS-485 (2) RS-422A

No	Description
13	Digital output 2 (DO 2)
14	Relay contact output
15	Digital output 3 (DO 3)
16	Relay contact output
17	Digital output 4 (DO 4)
18	Relay contact output
19	COM
20	CT1 CT2
21	Open (O) Close (C) Feedback resistance input
22	
23	
24	

CT : Current transformer for heater break alarm

## External Dimensions

Unit:mm

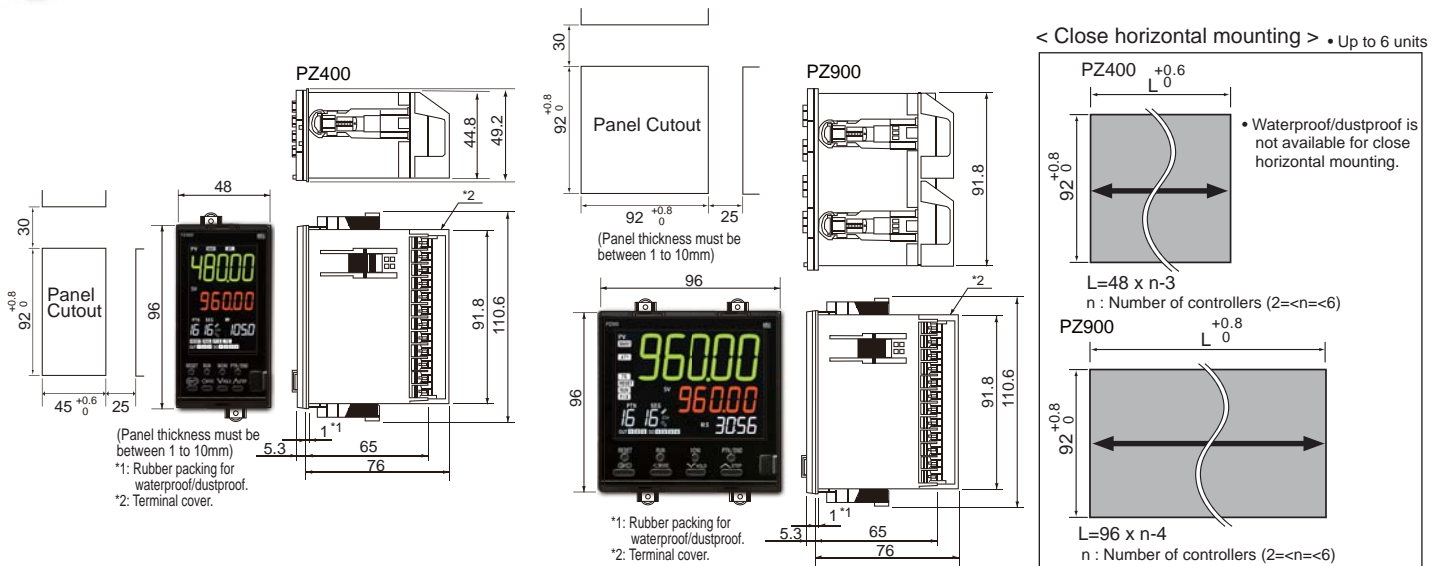

## Accessories

(Sold separately)

### Front Cover



Model code : KRB400-36



Model code : KRB900-36

### Terminal Cover



Model Code : KFB400-58



Model Code : KFB400-58  
 • Two pieces necessary

### CT : Current transformer for heater break alarm

Model : CTL-6-P-N  
 (0 to 30A)

Cable : Approx.130mm

Model : CTL-12-S56-10L-N  
 (0 to 100A)

Cable : Approx.100mm

Model : CTL-6-P-Z  
 (0 to 10A)

φ 5.8

(U.R.D.Co.,LTD product)

**Safety Warning**

- Before operating this product, read the instruction manual carefully to avoid incorrect operation.
- This product is intended for use with industrial machines, test and measuring equipment. It is not designed for use with medical equipment.
- If it is possible that an accident may occur as a result of the failure of the product or some other abnormality, an appropriate independent protection device must be installed.

**Caution for the export trade**  
 All transactions must comply with laws, regulations, and treaties.

**Caution for imitated products**  
 As products imitating our product now appear on the market, be careful that you don't purchase these imitated products. We will not warrant such products nor bear the responsibility for any damage and/or accident caused by their use.

**RKC® RKC INSTRUMENT INC.**  
 (RIKA KOGYO CO.,LTD)

HEAD OFFICE : 16-6, KUGAHARA 5 CHOME OHTA-KU TOKYO 146-8515 JAPAN  
 PHONE : 03-3751-9799 ( +81 3 3751 9799 )  
 Email : info@rkinst.co.jp  
 http://www.rkinst.com/